

RingFIX™ RAD

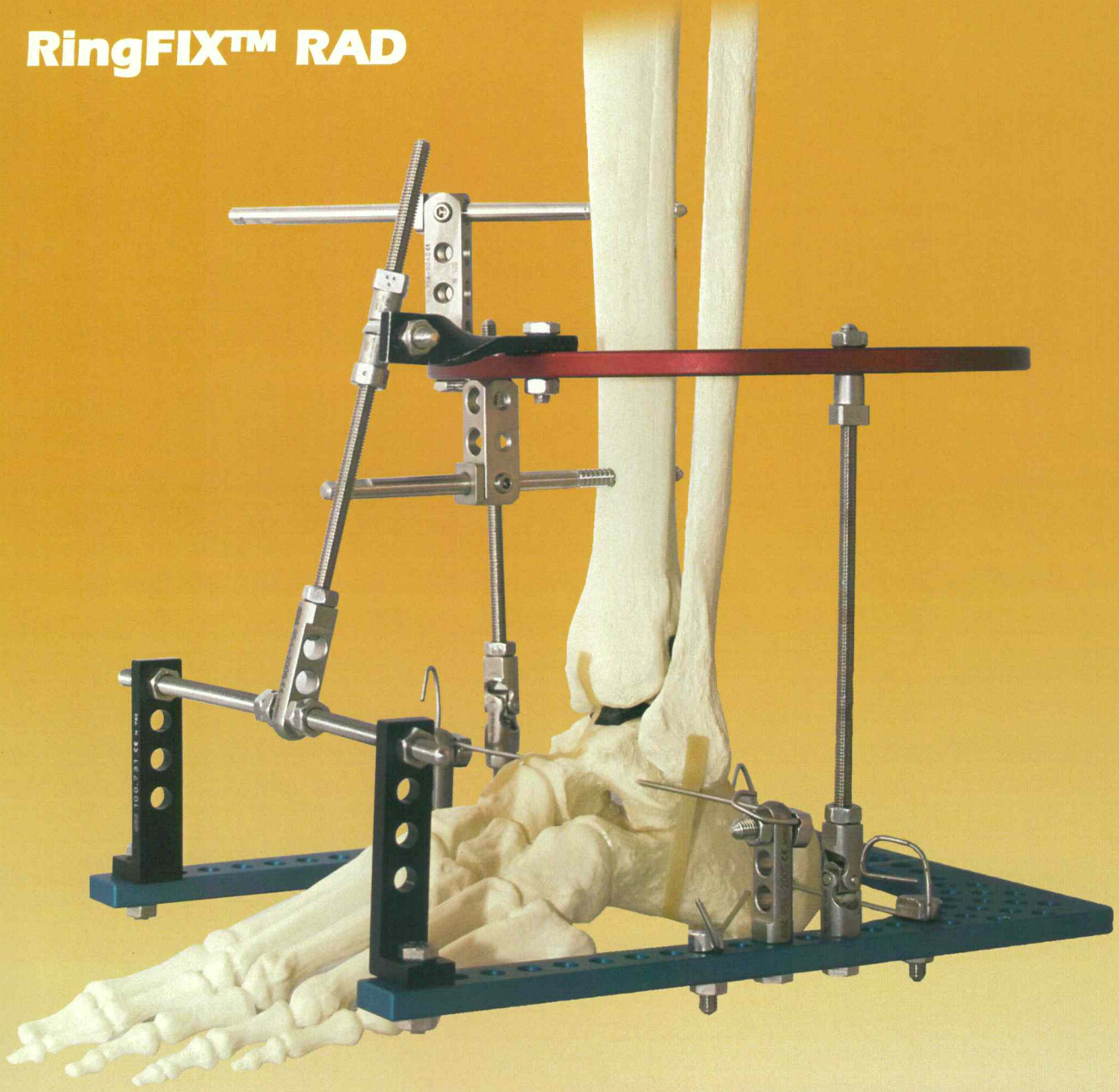

RingFIX™ **RAD**
ROZBRUCH ANKLE DISTRACTION

CONTENTS

Surgical Procedure

- | | |
|---------------------------------------|----|
| 1. Half Pin & Proximal Ring Placement | 1 |
| 2. Hinge Placement | 4 |
| 3. Foot Plate & Wire Placement | 7 |
| 4. Distraction | 15 |

Distraction Arthroplasty is indicated for patients with ankle osteoarthritis with preserved tibiotalar joint geometry and preservation of joint mobility. It serves as an alternative to ankle arthrodesis. This surgical protocol describes the application of the RAD articulated external fixator. Often the frame application is preceded by intraarticular surgery to stimulate cartilage healing. This typically involves arthroscopic or open debridement of anterior osteophytes and microfracture of denuded areas of the articular surface. Incisions should be kept small to prevent contamination between areas of dissection and the pin sites.

Acknowledgement: Small Bone Innovations, Inc. would like to acknowledge Dr. S. Robert Rozbruch and Dr. Austin Fragomen from the Institute for Limb Lengthening & Reconstruction, Hospital for Special Surgery NY, for their development of this surgical technique.

PROCEDURE

HALF PIN & PROXIMAL RING PLACEMENT

1 Half Pin & Proximal Ring Placement

Distal half pin

Placement of this half pin should be approximately 6 cm proximal to the medial malleolus.

Slide the ring onto the leg proximal to the proposed half pin insertion site.

Lay a 3-hole half pin post on the anterior crest of the tibia so that the most distal hole is 6 cm proximal to the medial malleolus and medial to the tibialis anterior tendon. (FIGURE 1)

Place a centering sleeve through the most distal hole in the 3-hole half pin post. Make a small incision in the skin and bluntly spread down to bone. Use a drill sleeve to protect the soft tissues.

Place the drill sleeve through the centering sleeve and drill with the 4.8mm drill.

Make sure to be perpendicular to the tibial shaft on lateral X-ray view while drilling through the two cortices.

Insert the half pin by hand through the half pin post, and attach the post to the ring with a 16mm bolt. This post should be two holes medial to the anterior twist plate. (FIGURE 2)

Use C-arm fluoroscopy to visualize the depth of half pin insertion and ensure bicortical purchase.

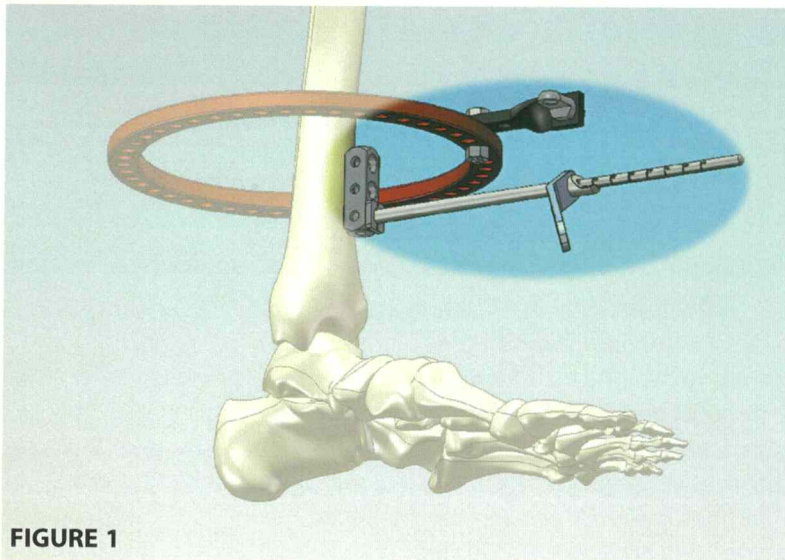

FIGURE 1

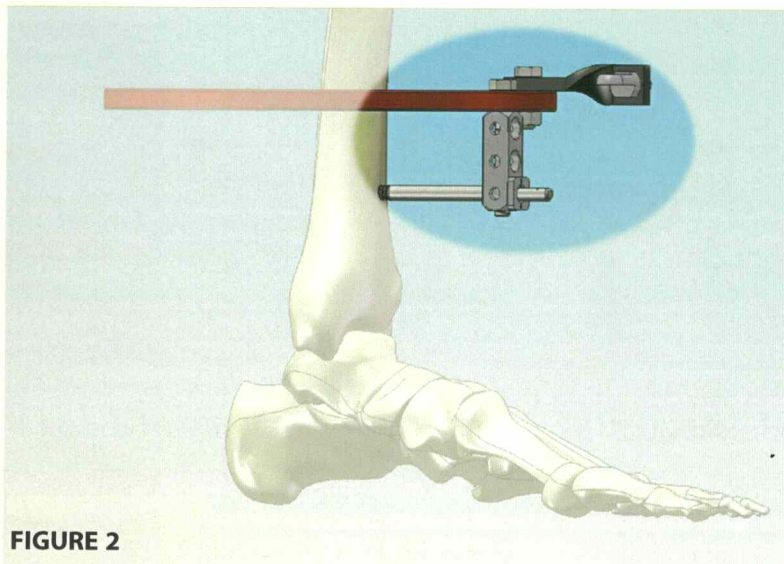

FIGURE 2

RingFIX™ RAD Surgical Technique

PROCEDURE

HALF PIN & PROXIMAL RING PLACEMENT

The ring should be orthogonal (perpendicular) to the axis of the tibia in the frontal plane before fully tightening the set screw. Confirm this with an A/P X-ray. (FIGURE 3A & 3B)

Make sure there is a minimum of two finger breadth space between the ring and the skin circumferentially. Tighten the half pin post to the ring by using a 1/2 inch wrench on the half pin post and a 10mm wrench on the 16mm bolt. Make sure the assistant holds the ring with two hands during this maneuver. Once the half pin post and pin are tightened, the ring position is provisionally set.

Note: When placing half-pins, make sure to drill and insert bi-cortical pins. Avoid uni-cortical pins (that miss the medulary canal) which place the bone at risk for fracture and bone necrosis.

Tighten the set screw to lock the half pin to the post. Be sure the arrow on the centering sleeve points towards the set screw.

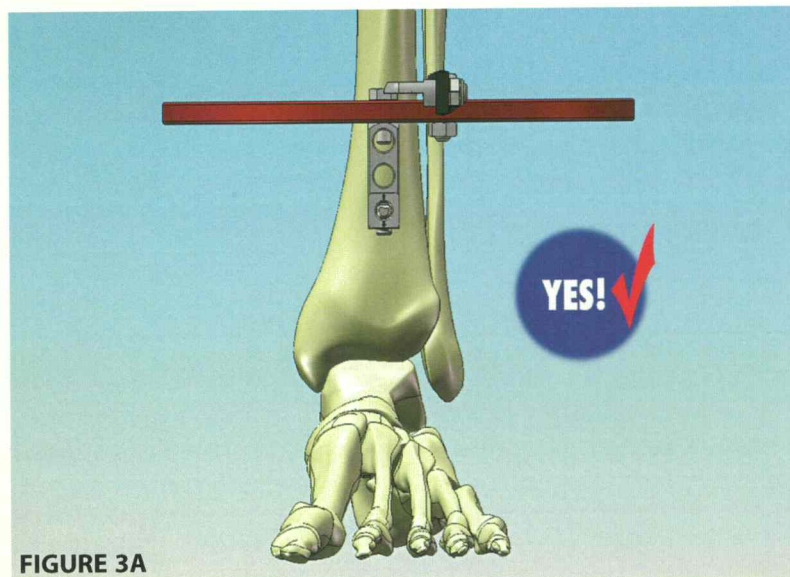

FIGURE 3A



FIGURE 3B

PROCEDURE

HALF PIN & PROXIMAL RING PLACEMENT

Proximal half pin

The location of this pin should be determined by the position of the ring. It should be positioned on the anterior/medial border of the tibia to obtain multiplanar fixation.

Attach a 3-hole half pin post to the ring with a 16mm bolt. This is typically placed 3 ring holes medially from the first 3-hole post (used for the distal half pin). Avoid positioning the half pin post more medially as it may interfere with the placement of the hinge.

Place a centering sleeve in the most proximal hole of the 3-hole post.

Place the drill guide through the centering sleeve and drill with the 4.8mm drill.

(FIGURE 4)

Insert the half pin through the half pin post and into the bone.

Tighten the set screw to lock the half pin to the half pin post and tighten the post to the ring. (FIGURE 5)

Note: Ring Alignment – once again check that the ring is orthogonal to the axis of the tibia in the frontal plane before fully tightening the set screw. Confirm with an A/P and lateral X-ray that the ring is perpendicular to the tibia in the frontal and sagittal planes.

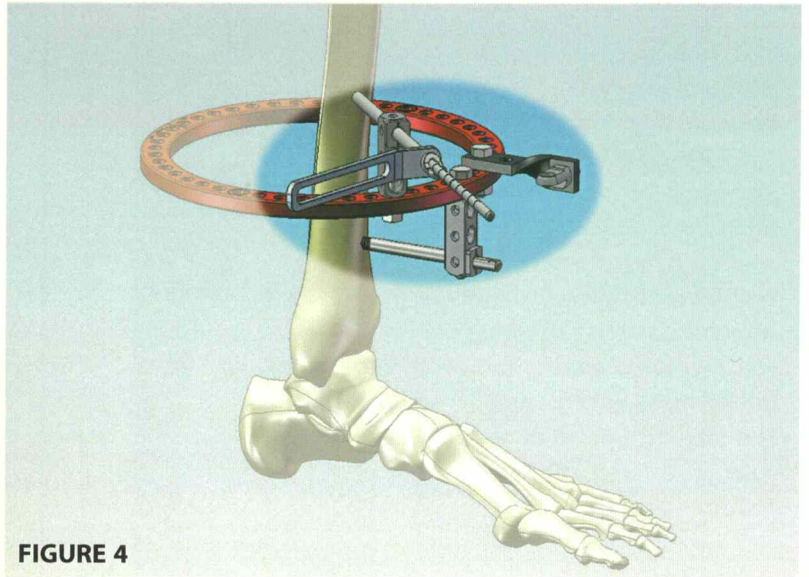

FIGURE 4

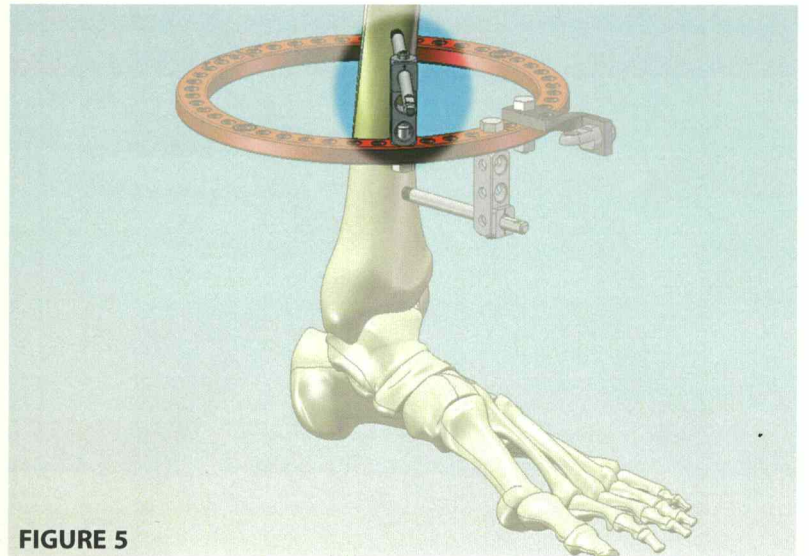

FIGURE 5

RingFIX™ RAD Surgical Technique

PROCEDURE HINGE PLACEMENT

2 Hinge Placement

Reference Wire Placement

The Ankle joint rotates about a single oblique plane axis. Determine the axis of the ankle utilizing a wire as your guide.

With fluoroscopic assistance, insert a smooth wire through the talus from the tip of the lateral malleolus aiming toward the tip of the medial malleolus.

The starting position is posterior/lateral. Aim your wire in an anterior/medial direction.

FIGURE (6A & 6B)

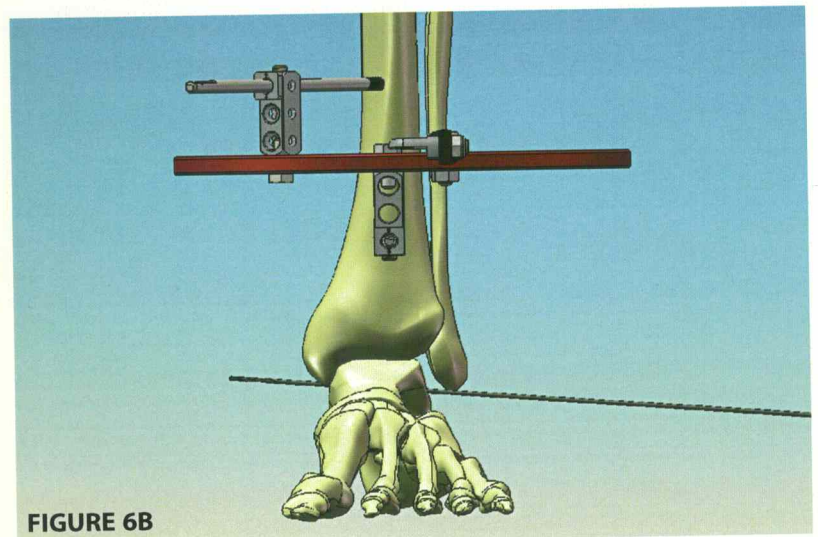
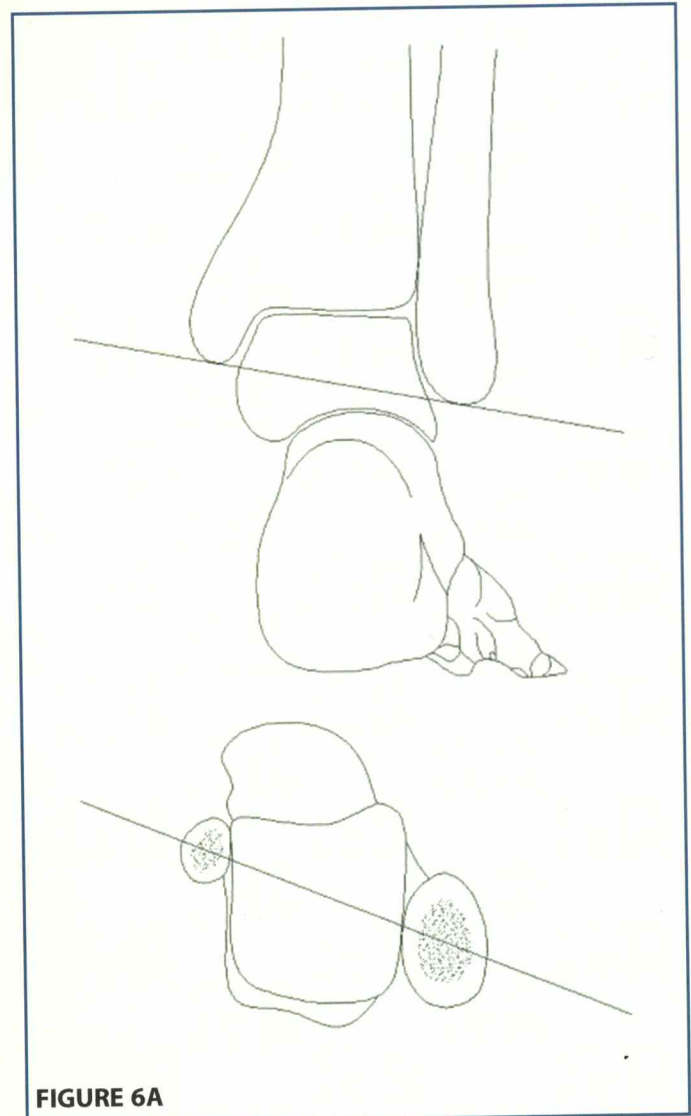

PROCEDURE

HINGE PLACEMENT

Check the orientation of your wire on a lateral X-ray with the beam centered along the wire. The leg will need to be internally rotated and abducted to achieve this X-ray view. (similar to the mortise view). The ideal placement of the wire is the center of the talus or slightly distal to the center. (FIGURE 6C)

Cut the ends of the wire just short enough so not to interfere with the placement of the hinges.

Note: Ideal wire placement is the center of the talus in the lateral view. There is no need to shoot a second wire if placement is not ideal. Make adjustments in your hinge placement to compensate for the wire placement. For example, if the wire is too posterior then the hinges should be placed anterior to the wire. As in (FIGURE 6D)

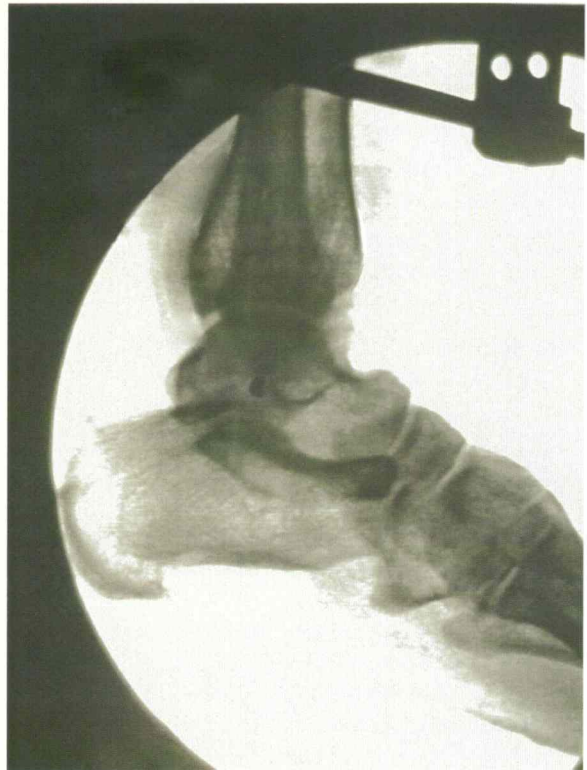

FIGURE 6C



FIGURE 6D

RingFIX™ RAD Surgical Technique

PROCEDURE HINGE PLACEMENT

Attaching the Hinges

Lateral Hinge

Attach the 150mm threaded rod/hinge assembly from the ring to the level of the wire. This requires the surgeon to find a hole on the ring that allows the rod and hinge to be aligned with the wire. The center of the hinge should be placed at the point where a perfectly placed wire would intersect the hinge. Make sure the square nut is distal to the ring to allow for distraction (**FIGURE 7A & 7B**).

If no hole on the ring allows the hinge to line up with the wire, then a short plate can be used to connect the rod to the ring so that the hinge will be better aligned.

Medial Hinge

Attach the 120mm threaded rod/ hinge/50mm threaded rod construct to the ring. (The 50mm threaded rod will be attached to the footplate.) Hinge placement is determined by the wire. The hinges should be placed at the point where a perfectly placed wire would intersect the hinge. Adjust the placement of the hinge/rod assembly accordingly.

(**FIGURE 7A-B**)

Note: Both hinges should be oriented along the ankle axis to allow for the smooth articulation of the frame. Always hold the hinge in place with a wrench when tightening the rods to the ring to prevent spinning the hinges once the proper orientation has been established. Then remove the talus axis wire.

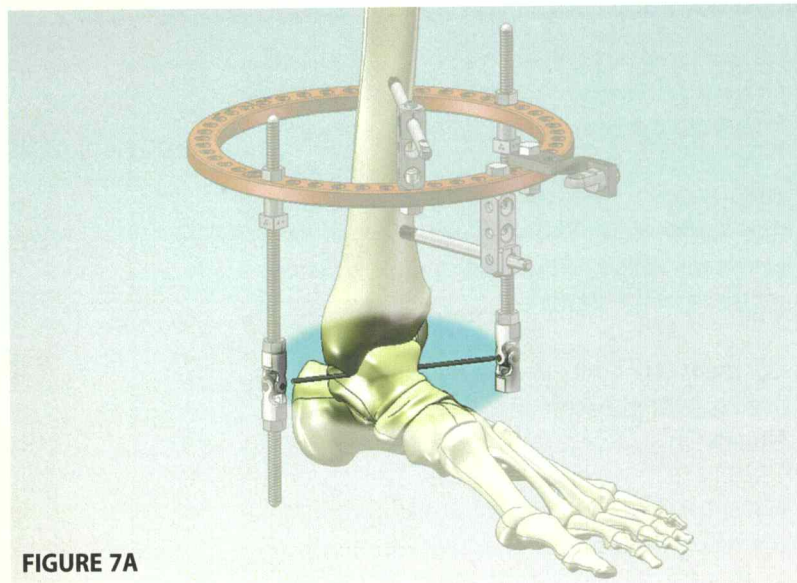

FIGURE 7A

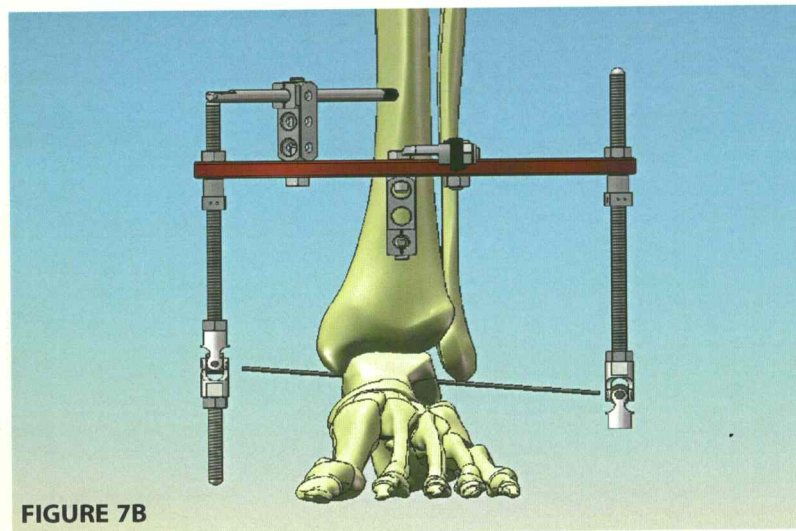

FIGURE 7B

PROCEDURE

FOOT PLATE & WIRE PLACEMENT

3 Mounting the Footplate

Hold the foot and ankle in a neutral position. To do this, wrap a gauze bandage around the ball of the foot and fasten it to the proximal ring. (FIGURE 8)

The surgeon should sit at the foot of the table to position the footplate. The footplate should be parallel to the sole of the foot in the sagittal plane and should match the shape and orientation of the foot in the axial plane. (FIGURE 9A-B)

The assistant should attach the foot ring directly to the lateral hinge with a 16mm bolt.

Then the foot plate should be attached to the medial hinge via the short rod. (FIGURE 9B)

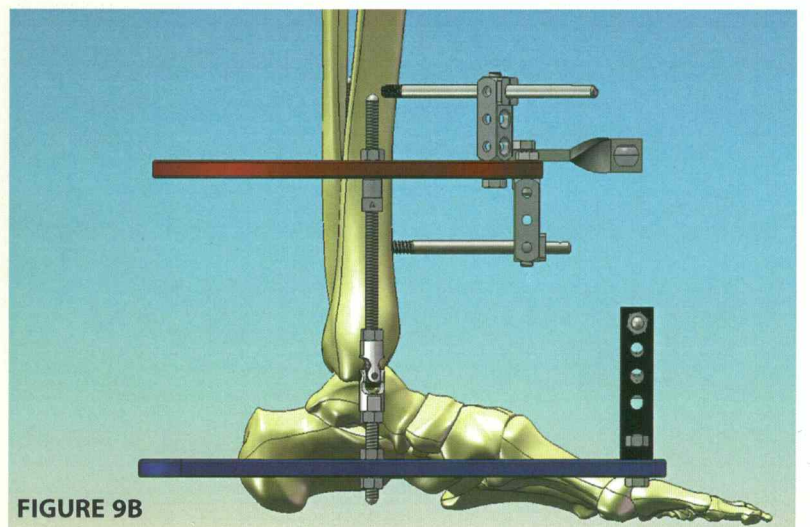
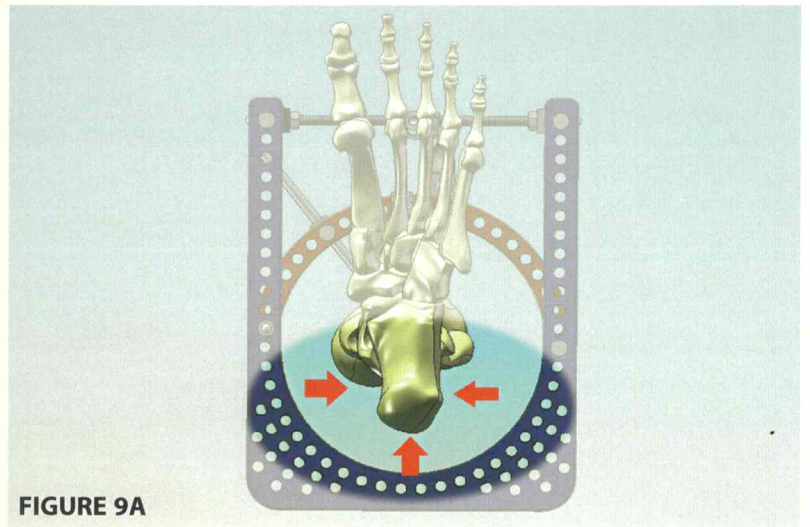

RingFIX™ RAD Surgical Technique

PROCEDURE

FOOT PLATE & WIRE PLACEMENT

Footplate Alignment: Make sure the footplate fits with at least 2 finger breadths room around all sides of the foot. Make sure footplate is parallel to bottom of foot and the plantar surface of the foot extends about 1 inch beyond the plate.

The medial hinge construct does not always fit directly into the hole of the footplate as in (FIGURE 10A). If direct connection is not possible, then there are 2 options for attaching this construct to the footplate:

If the connection is off by a small amount, then use conical washers above and below footplate. (FIGURE 10B)

If the connection is off by a greater amount, then use a 3-hole connection plate. This can be slightly angled or set perpendicular to the footplate depending on the amount of translation required. (FIGURE 10C)

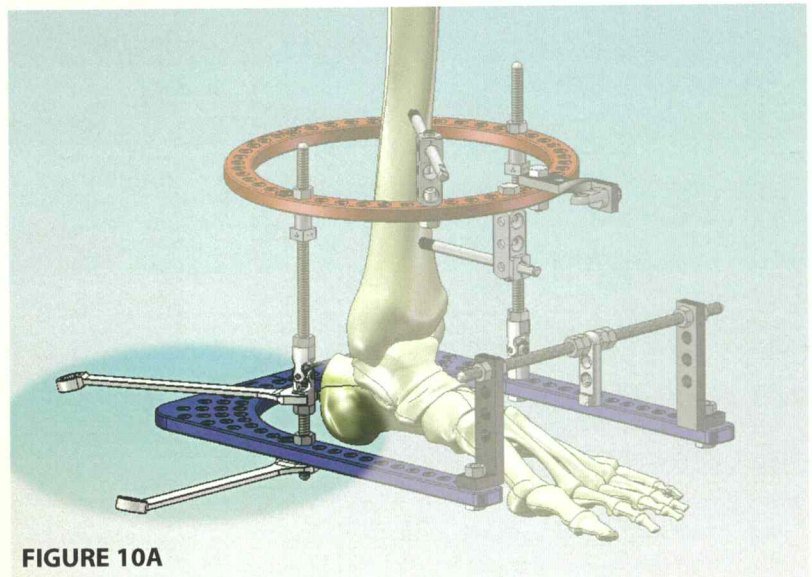

FIGURE 10A

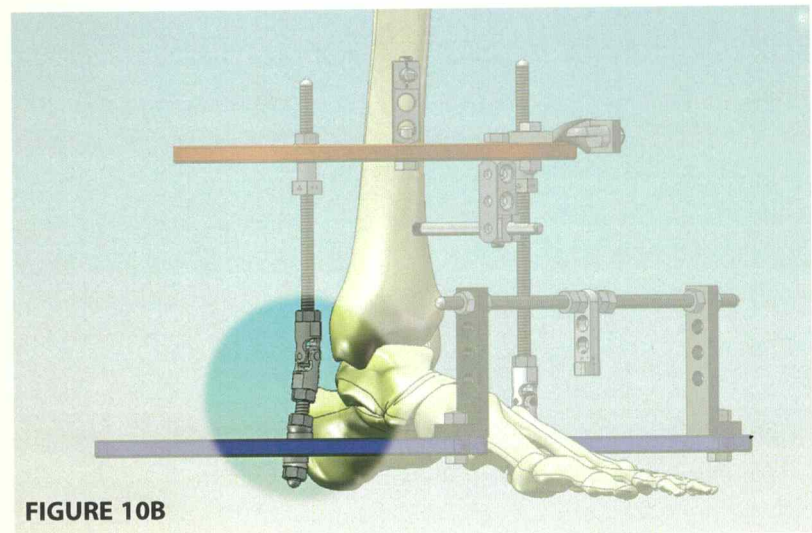

FIGURE 10B

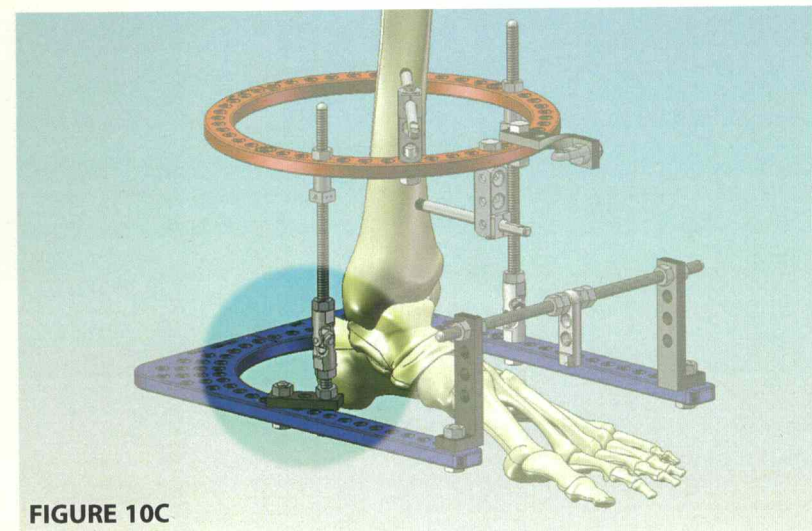

FIGURE 10C

PROCEDURE

FOOT PLATE & WIRE PLACEMENT

Once connected, articulate the footplate through the full ROM to ensure smooth motion. (FIGURE 11A & 11B)

Correct hinge orientation should allow the frame to move from dorsiflexion/external rotation to plantar flexion/internal rotation.

1st wire:

Insert an olive wire transversally through the calcaneus from lateral to medial taking care to avoid medial neurovascular structures. (FIGURE 12)

Calcaneal Safe Zone:

Posterior part of the calcaneus (blue zone)
Direct the wire to avoid the neurovascular bundle on the medial side. Avoid wire placement in the red zone. (FIGURE 12)

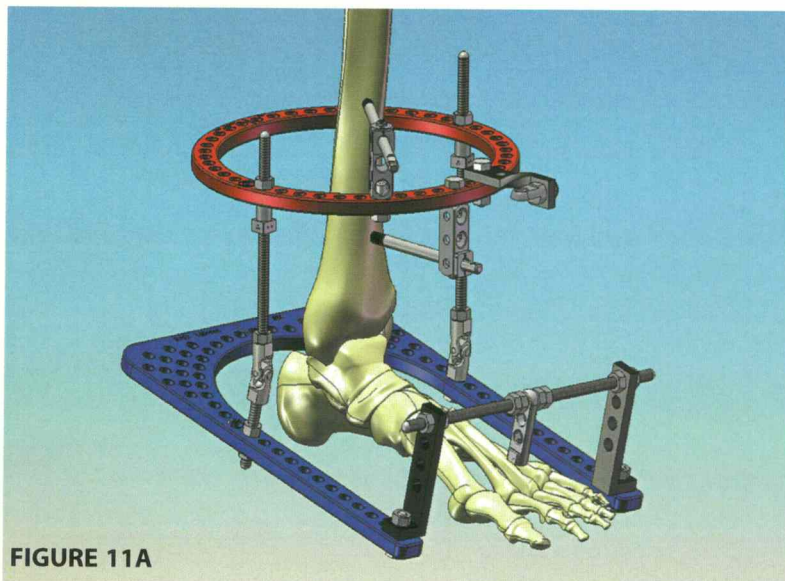

FIGURE 11A

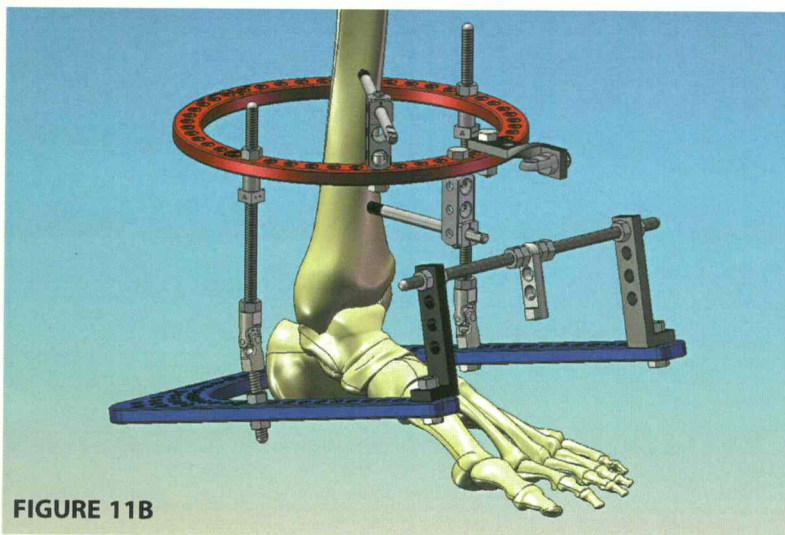

FIGURE 11B

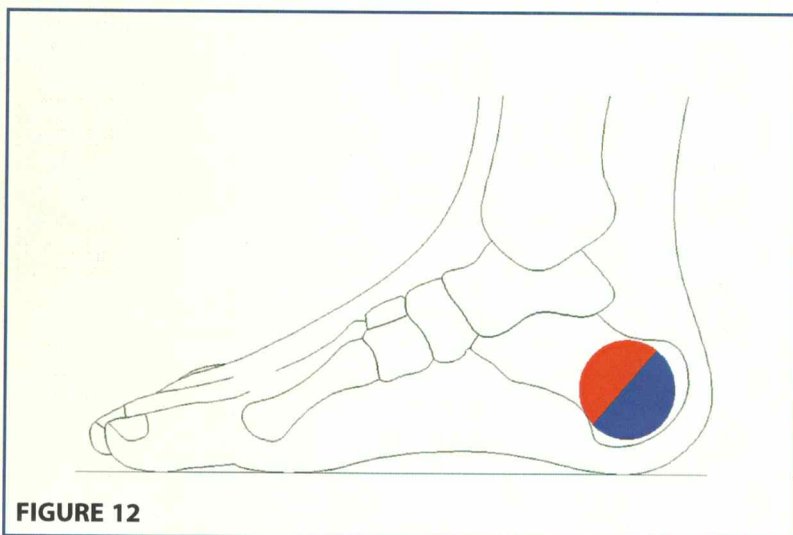

FIGURE 12

RingFIX™ RAD Surgical Technique

PROCEDURE

FOOT PLATE & WIRE PLACEMENT

Tap the olive wire until the olive makes contact with the bone. (**FIGURE 13**)

Attach the wire to the footplate with wire fixation bolts.

Tighten the wire fixation bolt with two 10mm wrenches on the olive side of the wire (striped). Always hold the fixation bolt in place while tightening the nut.

Using the tensioner, tension the opposite side of the wire (110-130 Kg). (**FIGURE 13**)

Tighten the wire fixation bolt on the tensioned side of the wire.

Remove the tensioner.

Cut the ends of the wire so that about 2cm remain and curl the remaining ends towards the ring.

2nd wire:

Insert an olive wire (medial to lateral) through the talar neck or body aiming anterior to the fibula.

Confirm the starting point of the wire on a lateral X-ray.

Ensure the wire will not exit too close to the hinges and avoid the fibula. (**FIGURE 14**)

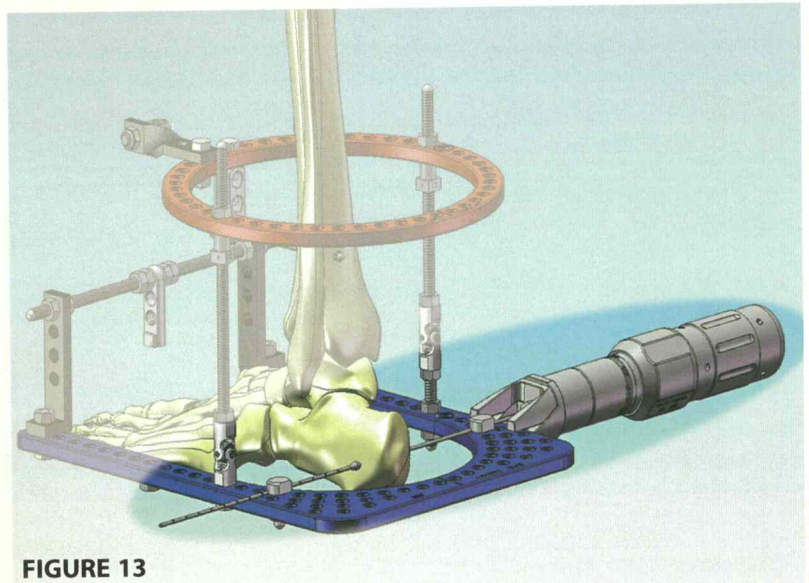

FIGURE 13

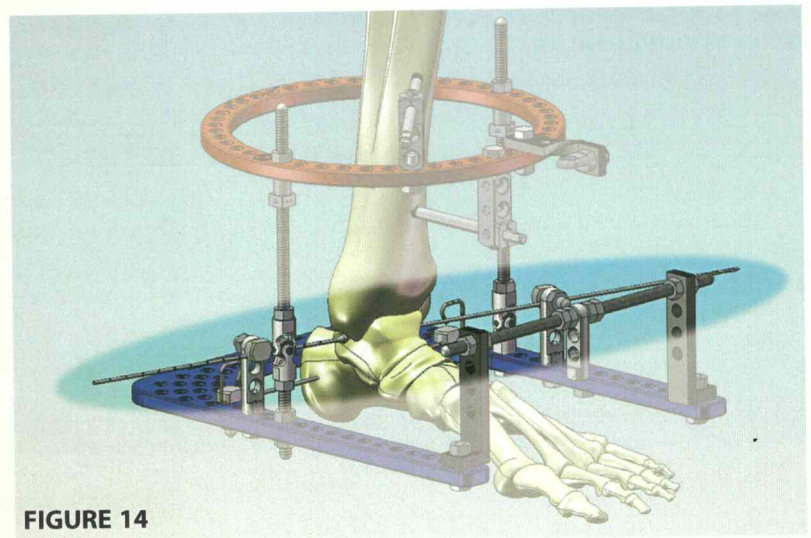

FIGURE 14

PROCEDURE

FOOT PLATE & WIRE PLACEMENT

Build the frame to the wire by utilizing female posts and wire fixation bolts.

Tighten the female posts to the footplate with 16mm bolts on both the medial and lateral sides.

Tighten the wire fixation bolt on the olive side of the wire.

Slide a socket over the opposite side of the wire to maintain space between the post and the tensioner.

(FIGURE 15A & 15B)

Tension the non-olive side of the wire to between 50 to 90 Kg or until the posts bend, whichever occurs first.

Tighten the wire fixation bolt on the tensioned side of the wire.

Remove the tensioner.

3rd Wire:

Insert a smooth wire through the calcaneus – starting position is the posterior/medial calcaneus aiming toward the anterior/lateral calcaneus. A 40 degree angle between the two calcaneal wires is desirable.

(FIGURE 16)

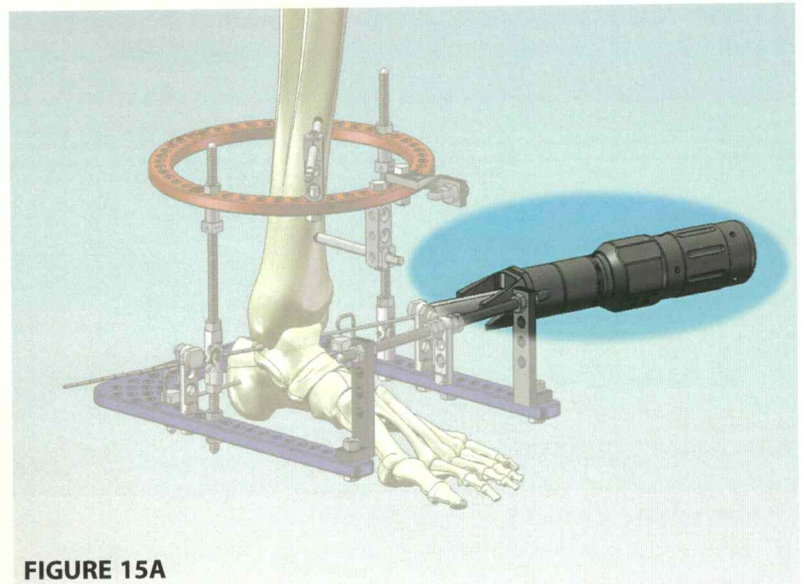

FIGURE 15A

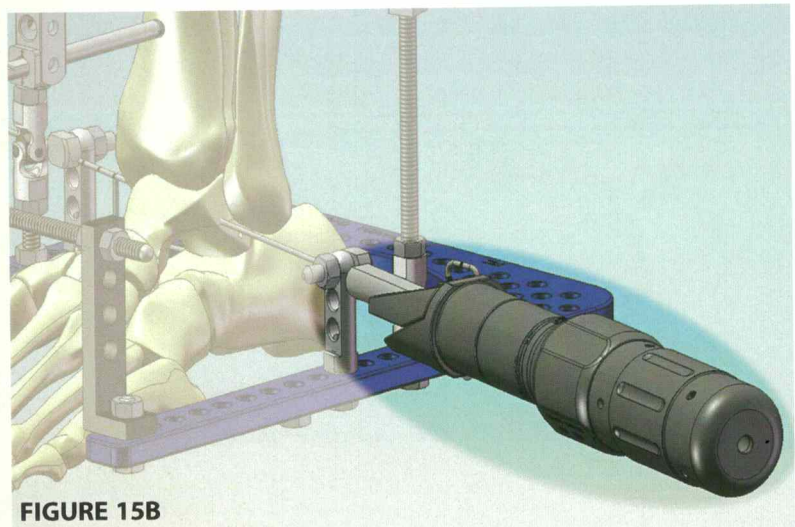

FIGURE 15B

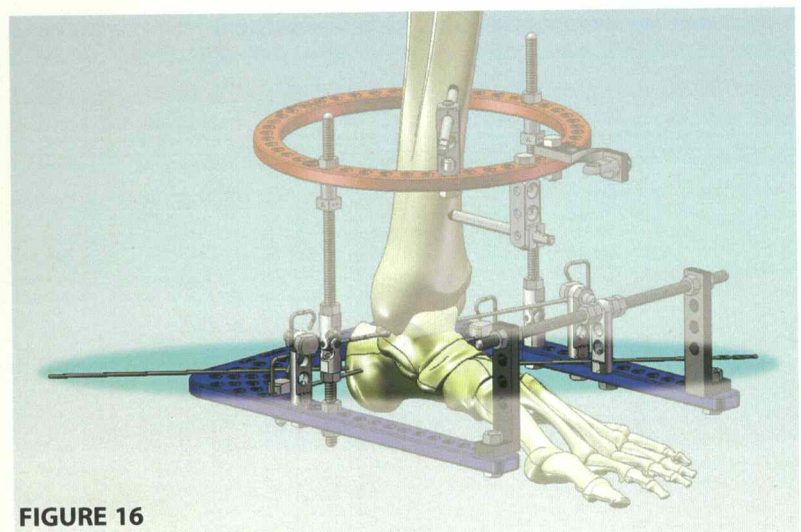

FIGURE 16

RingFIX™ RAD Surgical Technique

PROCEDURE

FOOT PLATE & WIRE PLACEMENT

Attach the wires to the footplate with wire fixation bolts.

Tighten the wire fixation bolt on one side of the wire. Tension the opposite side (110-130 Kg).

Tighten the wire fixation bolt on the tensioned side of the wire.

Remove the tensioner. (FIGURE 17)

Attachment of the Locking Rod

Slide the threaded rod through the male hinge connected to the twistplate toward the knee. (FIGURE 18A)

Thread the opposite end of the rod to the the 3 hole female post. Tighten the nut to the post. (FIGURE 18B & C)

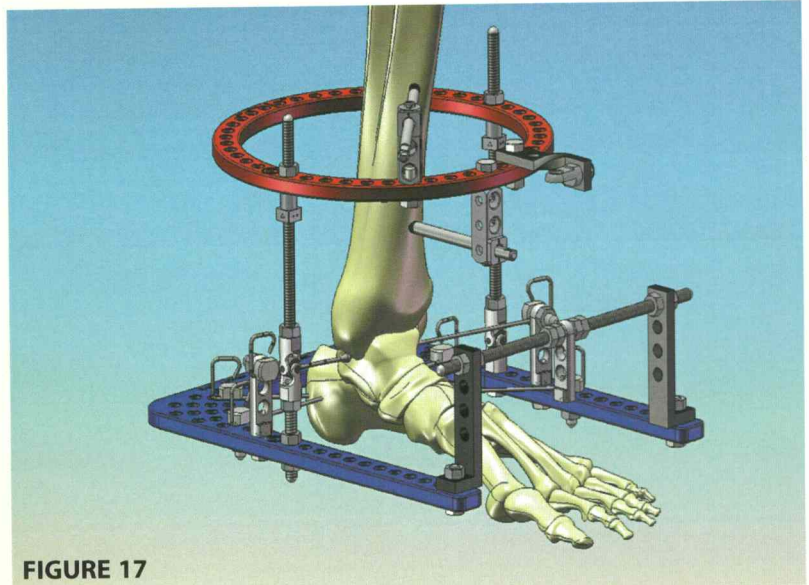

FIGURE 17

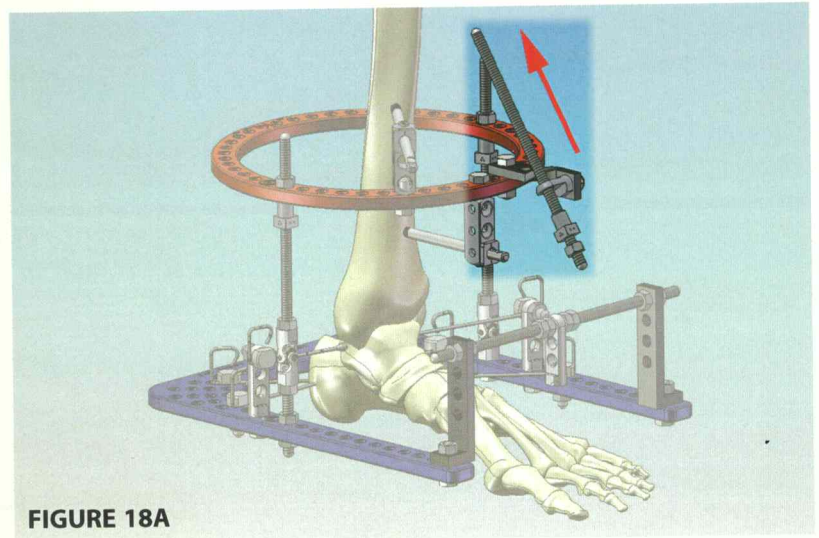

FIGURE 18A

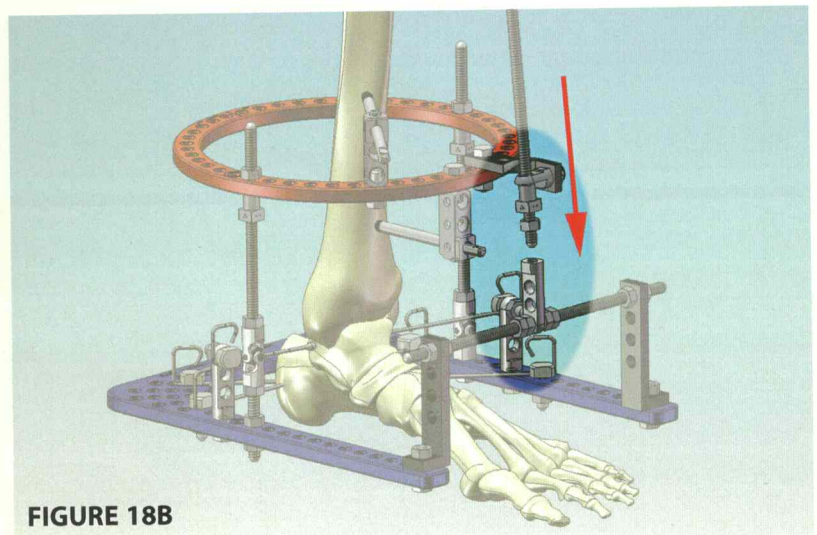

FIGURE 18B

PROCEDURE

FOOT PLATE & WIRE PLACEMENT

Thread the second square nut on the proximal end of the rod.

(FIGURE 18D)

Place the foot/ankle in a neutral position. Lock the square nuts to maintain this position.

(FIGURE 18E)

Measure and record the length of the threaded rod above the square nut. This measurement will be needed to ensure that the foot/ankle is placed back into a neutral position after ROM exercises. (FIGURE 18E)

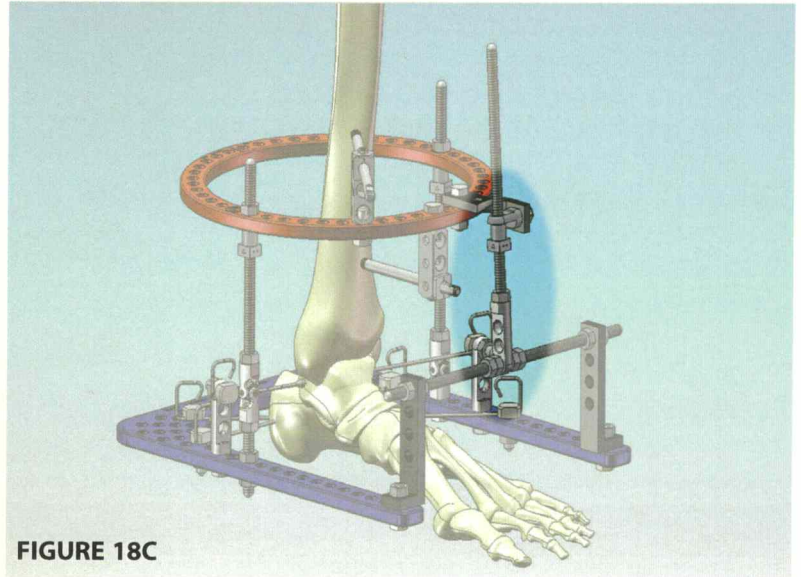

FIGURE 18C

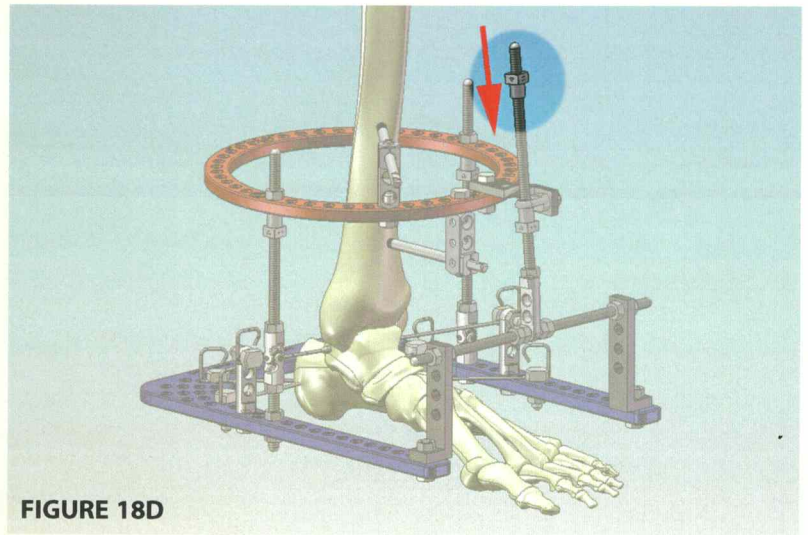

FIGURE 18D

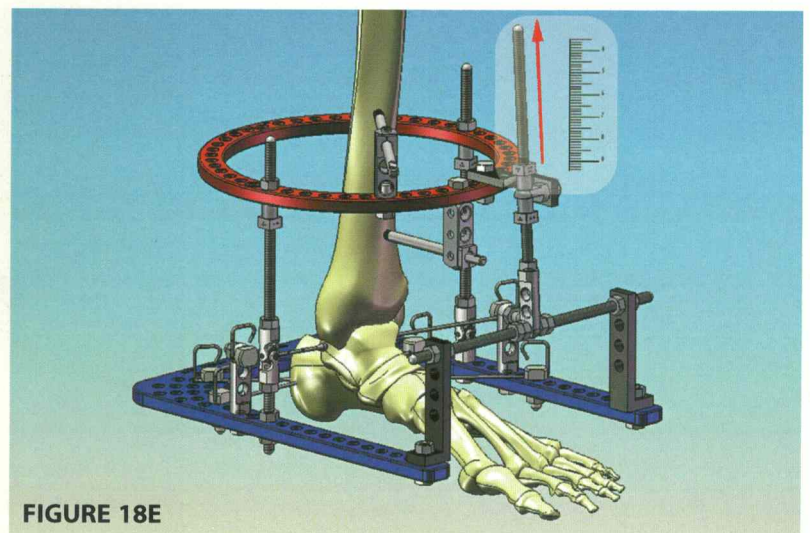

FIGURE 18E

RingFIX™ RAD Surgical Technique

PROCEDURE

FOOT PLATE & WIRE PLACEMENT

The square nuts are tightened to lock the frame in place with ankle in neutral position.

Loosen the square nuts to check the movement of the frame. Make sure the frame and ankle move freely and the ankle joint moves concentrically.

This may be checked under fluoroscopy in the lateral position. Patients will do this several times a day to practice ROM exercises during recovery. The frame should then be locked in the neutral position.

(FIGURE 19A & 19B & 19C)

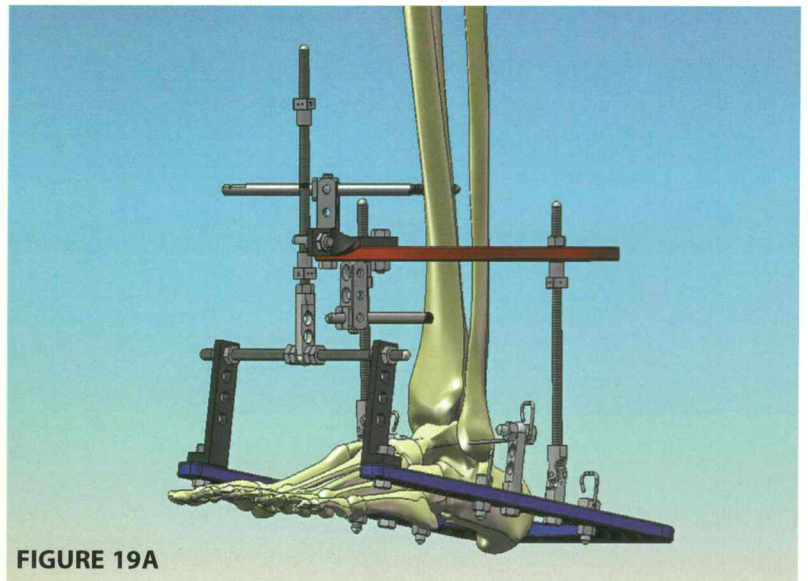

FIGURE 19A

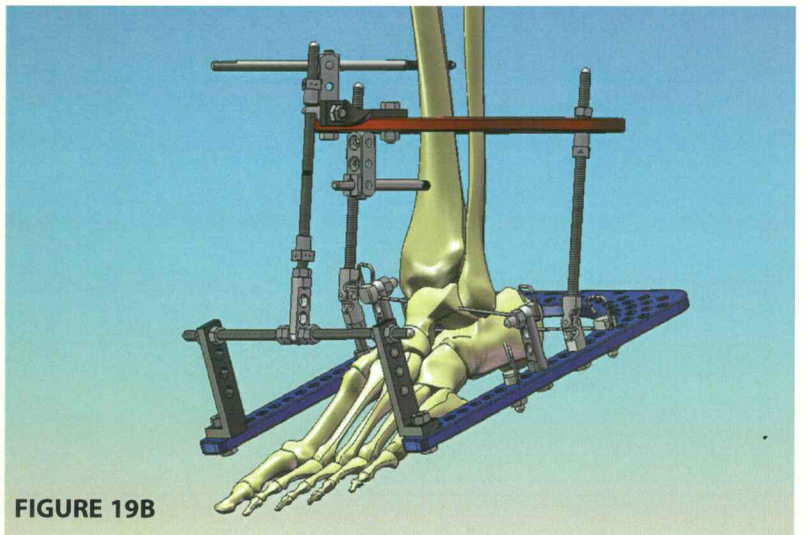

FIGURE 19B

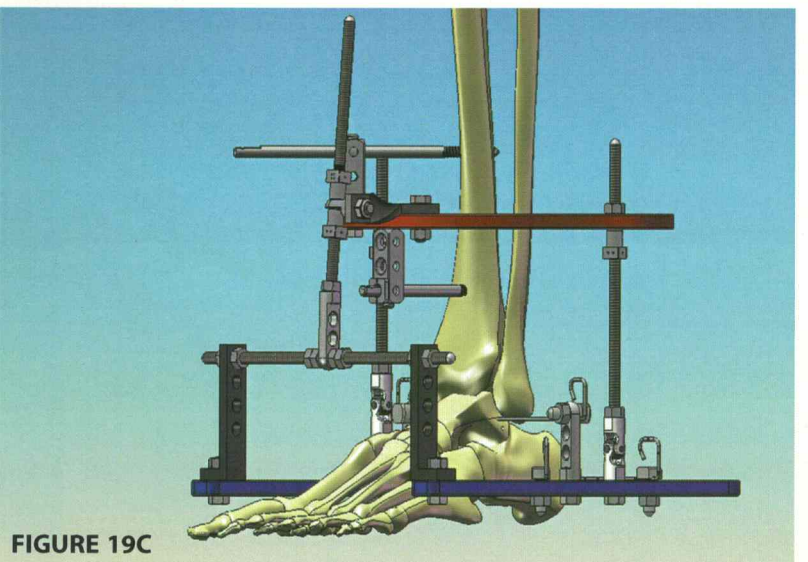

FIGURE 19C

PROCEDURE

DISTRACTION

4 Distraction

Make sure foot/ankle is in Neutral position—lock frame in place.

Loosen the hex nuts (on proximal side of the tibial ring) that attach the threaded rod/hinge construct to the rings. (FIGURE 20A)

Distraction the frame by rotating the square nuts (on distal side of the tibial ring) on each rod. This is a tightening or clockwise rotation so the numbers etched into the cube are increasing. (FIGURE 20B)

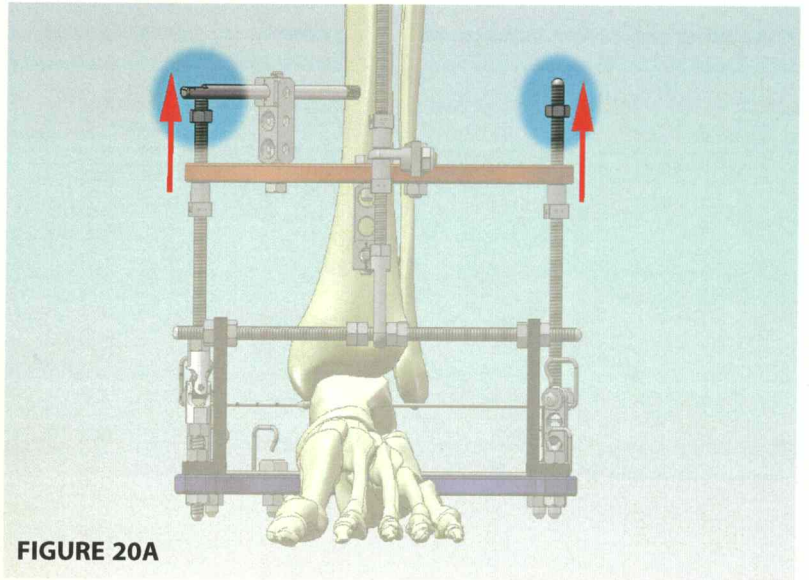

FIGURE 20A

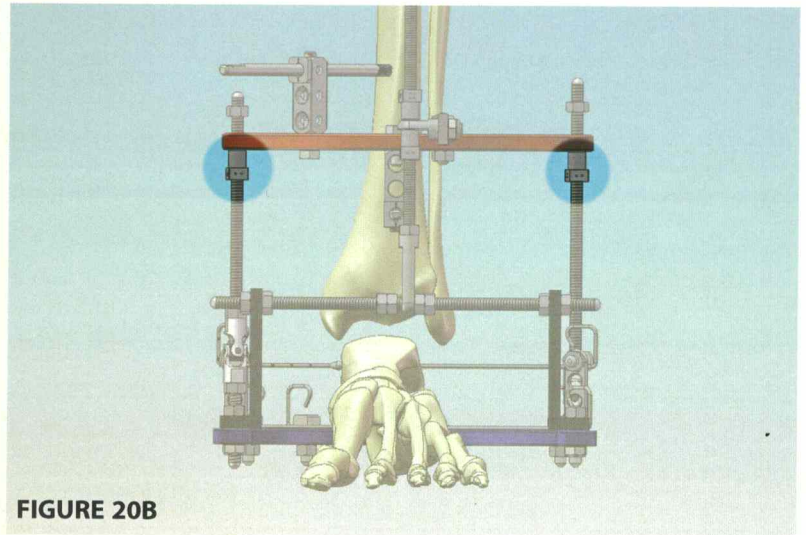

FIGURE 20B

RingFIX™ RAD Surgical Technique

PROCEDURE DISTRACTION

One full turn of the square nut = 1mm.

This needs to be done progressively on each side. For example, distract the lateral side 1mm and then distract the medial side 1mm. Repeat this process—approximately 5mm is the distraction goal. Then fasten the round nut proximal to the ring. (FIGURE 20C)

Note: Always be sure to hold the hinges with the wrench so not to change the orientation of the hinges when loosening or tightening nuts. (FIGURE 20D)

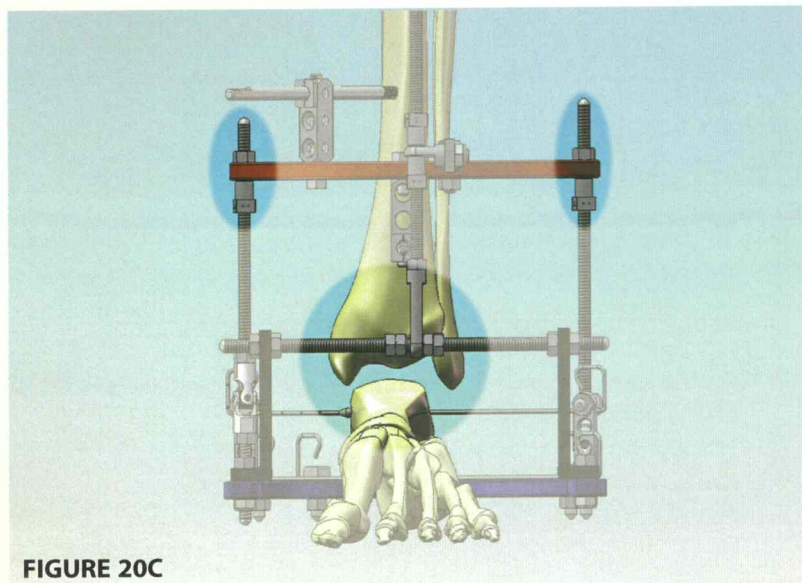

FIGURE 20C

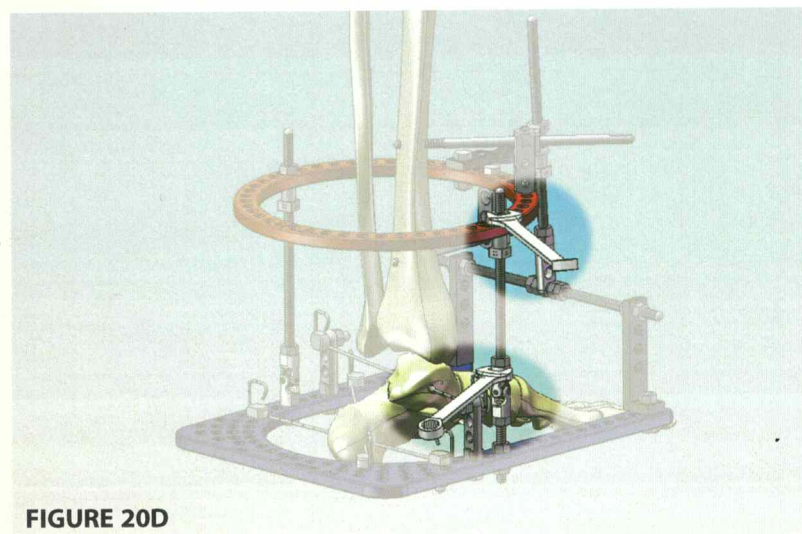

FIGURE 20D

PROCEDURE

DISTRACTION

Range of Motion

Release the two square nuts on the locking rod. The frame can now articulate for therapy. (FIGURE 21A & 21B)

Tighten the square nuts and return the frame to a neutral position.

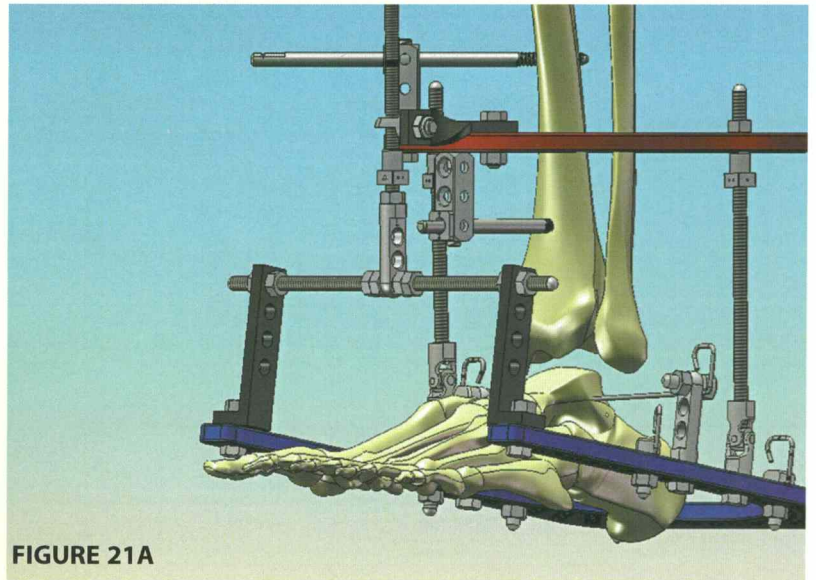

FIGURE 21A

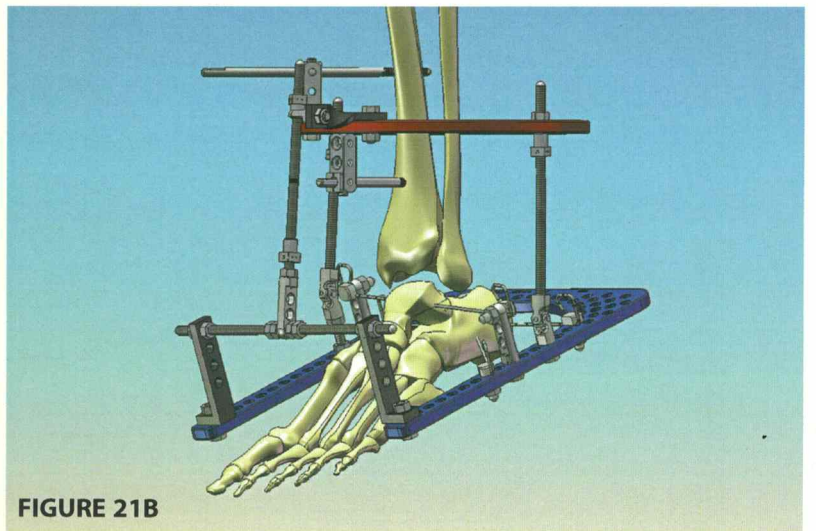

FIGURE 21B

RingFIX™ RAD Surgical Components

RING ASSEMBLY



Part No.	Size
950-0140	140mm
950-0160	160mm
950-0180	180mm

FOOTPLATE ASSEMBLY

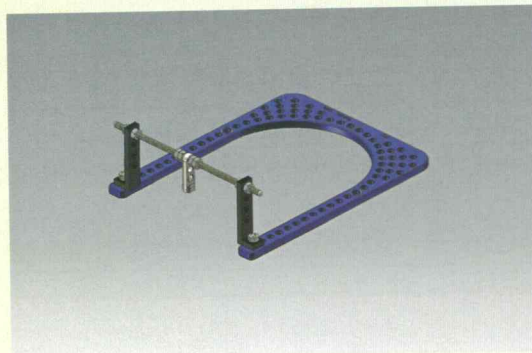

Part No.	Size
952-0140	140mm
952-0160	160mm
952-0180	180mm

THREADED ROD & UNIVERSAL HINGE ASSEMBLY

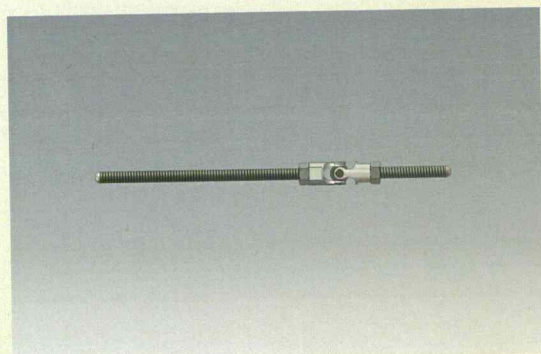

Part No.	Size
954-1250	120mm x 50mm

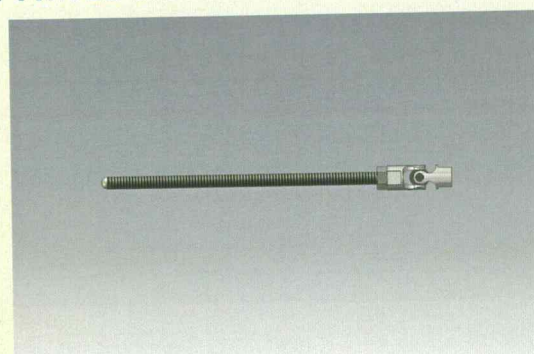

Part No.	Size
956-1500	150mm

3 HOLE CONNECTION PLATE

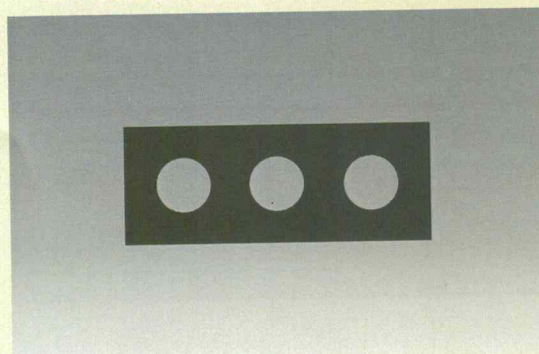

Part No.
953-0040

CONICAL WASHER SET



Part No.
955-1050

HALF PINS

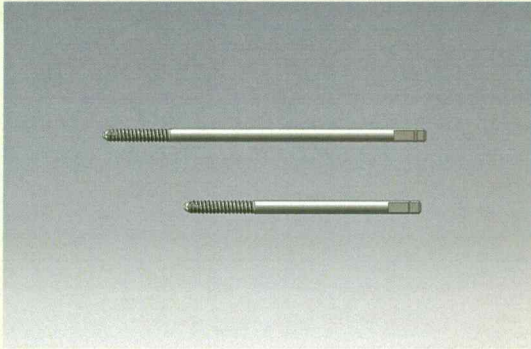

Part No.

Size

450-2526 6mm x 150mm x 30mm

450-2500 6mm x 110mm x 30mm

3 HOLE HALF PIN POST

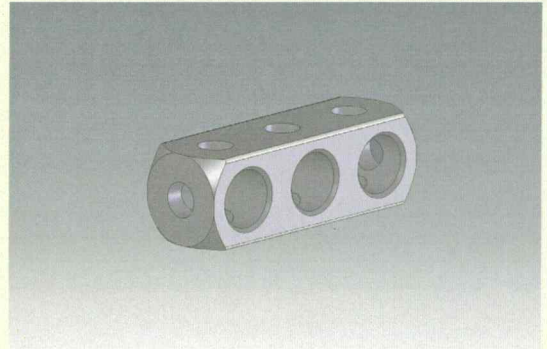

Part No.

954-0035

CENTERING SLEEVE

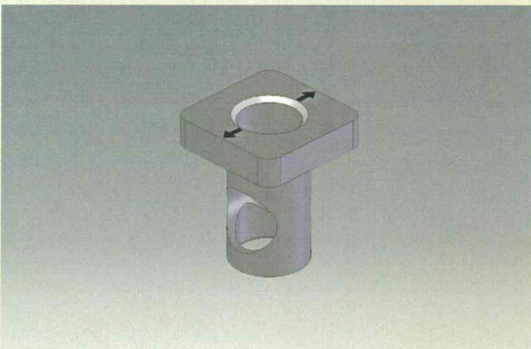

Part No.

959-0035

SET SCREW



Part No.

930-0017

RingFIX™ RAD Surgical Components

LOCKING NUT

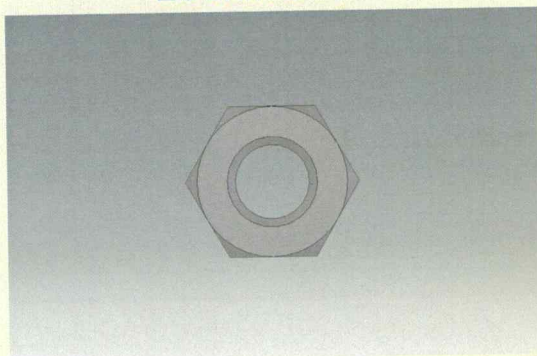

Part No.
955-0005

DRILL TIP WIRES

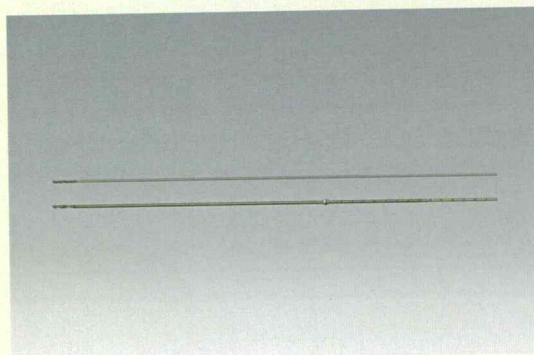

Part No.
451-3003-Smooth
451-3004-Olive

SLOTTED WIRE FIXATION BOLTS

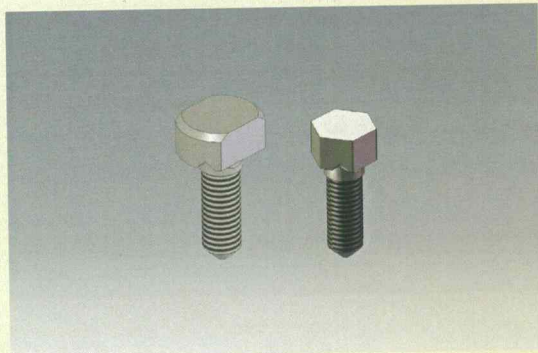

Part No.
954-0010-Standard
954-0050-Low Profile

SQUARE WASHER

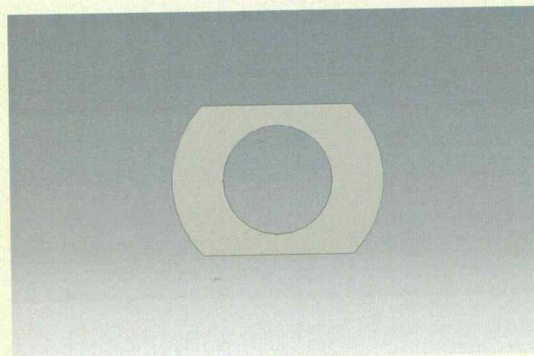

Part No.	Size
955-1008	2mm
955-1010	4mm

POSTS

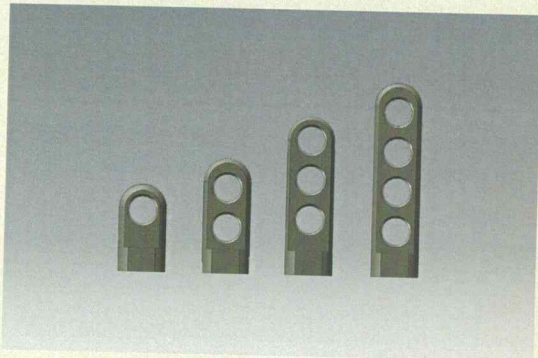

Part No.	Size
----------	------

954-1015	1 hole
----------	--------

954-2000	2 hole
----------	--------

954-2005	3 hole
----------	--------

954-2010	4 hole
----------	--------

SQUARE NUT

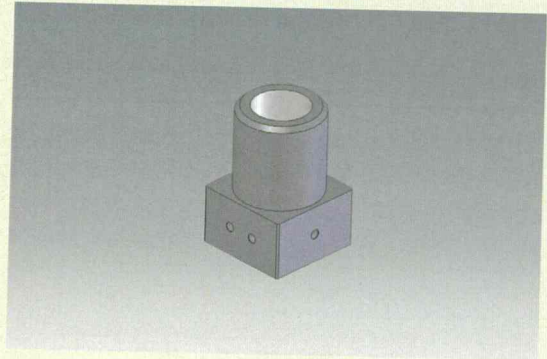

Part No.

955-1035

LOCKING ROD ASSEMBLY

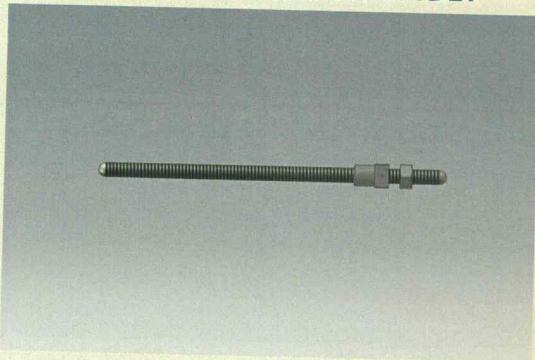

Part No.	Size
----------	------

956-1501	150mm
----------	-------

BOLTS



Part No.	Size
----------	------

957-0616	16mm
----------	------

955-1003	20mm
----------	------

RingFIX™ RAD Surgical Components

60MM THREADED SOCKET

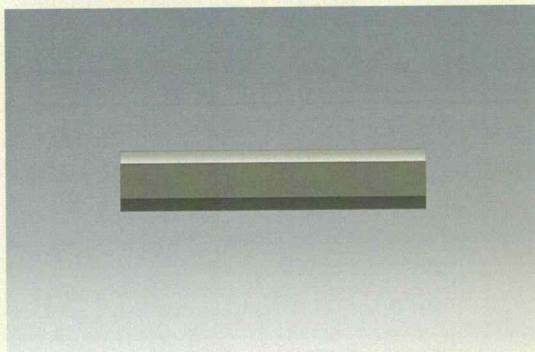

Part No.

955-2020

SILICONE HALF PIN CAP AND SILICONE WIRE CAP

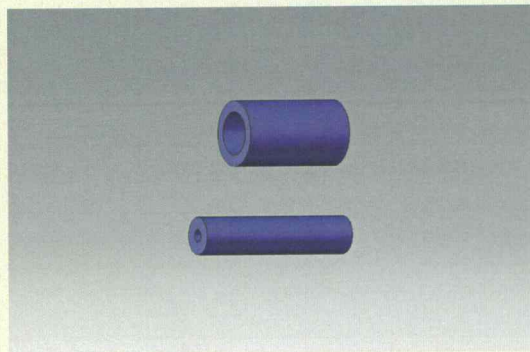

Part No.

930-0016

Size

6mm

930-0015

2mm

WIRE TENSIONER BOOSTER

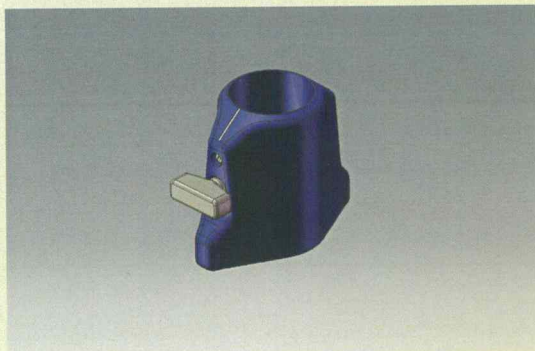

Part No.

958-2010

WIRE TENSIONER



Part No.

959-0040

DRILL GUIDE

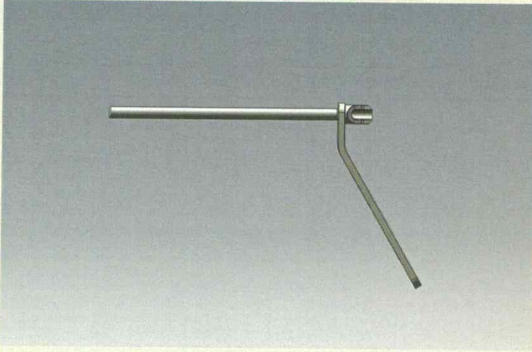

Part No.	Size
908-0061	4.8mm

HALF PIN DRILL

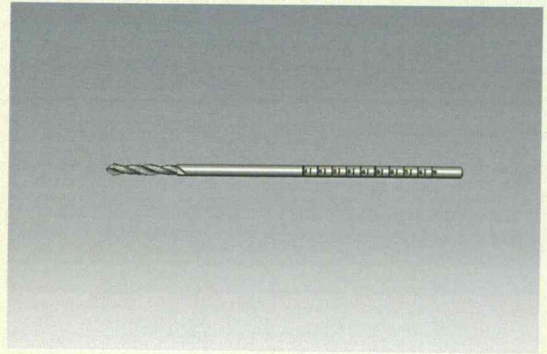

Part No.	Size
905-0037	4.8mm

T-HANDLE HALF PIN INSERTER

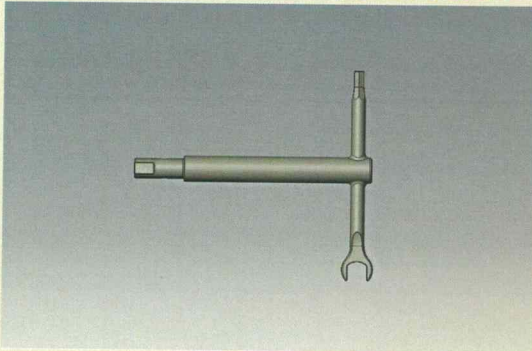

Part No.
450-0025

ALLEN WRENCH (SET SCREW)

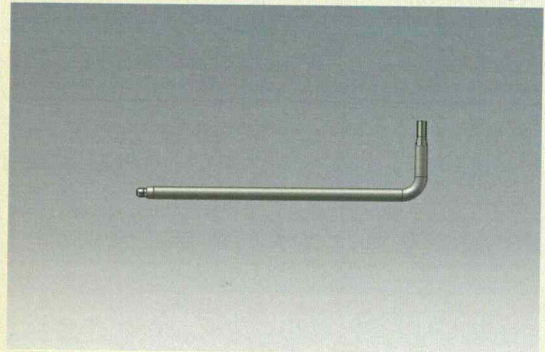

Part No.	Size
904-0030	3mm

RingFIX™ RAD Surgical Components

BOX WRENCH

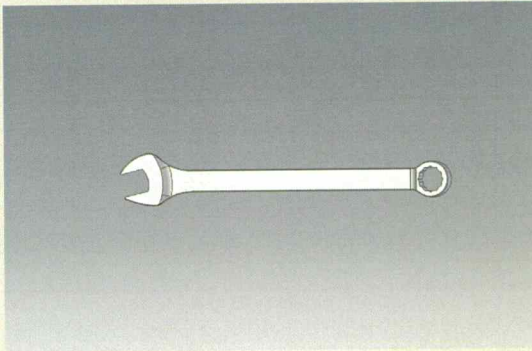

Part No.	Size
904-1000	10mm-Open

HALF PIN POST WRENCH

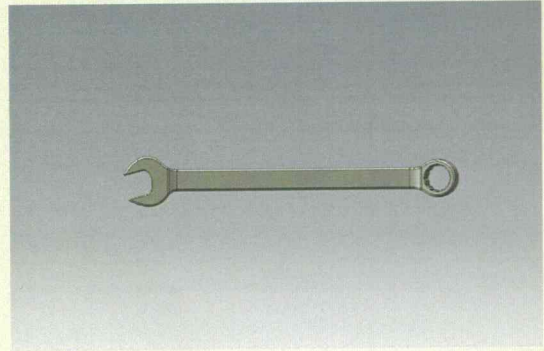

Part No.	Size
904-0031	12.5mm

TUBULAR WRENCH

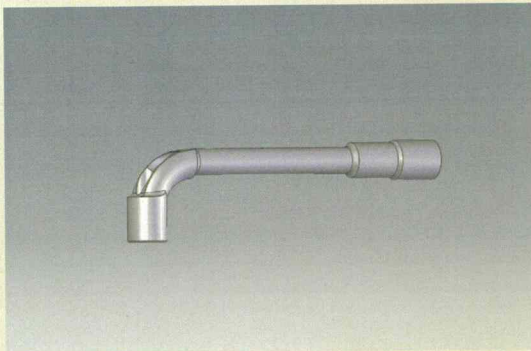

Part No.
904-1005

SLOTTED FIXATION BOLT WRENCH

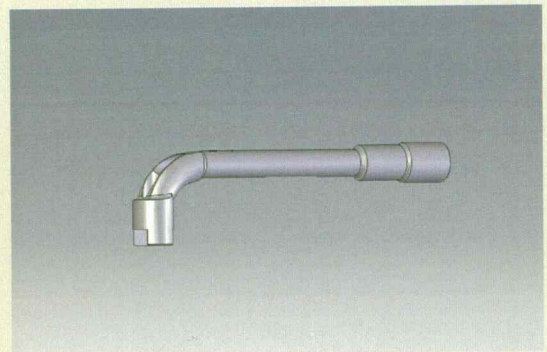

Part No.
904-0025

US FDA regulations restrict the sale of this device to or on the order of a physician.

Small Bone Innovations, Inc.

1380 South Pennsylvania Ave.

Morrisville, PA 19067

Customer Service (800) 778-8837

Technical Support (866) SBI-TIPS

Fax (215) 428-1795

www.totalsmallbone.com

SBi International, SAS

ZA les Bruyeres

BP 28

01960 Peronnas

France

Tel +33 474 21 58 19

Fax +33 474 21 43 12

info@sbi-intl.com